

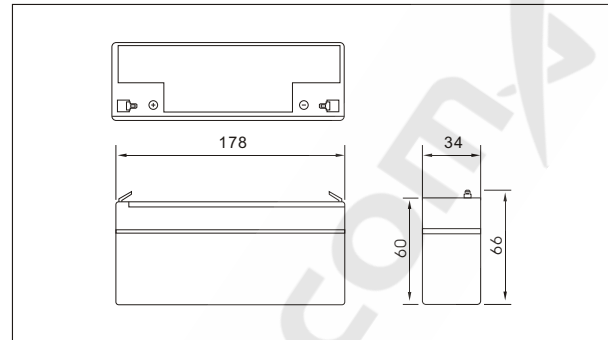

SW1223(12V 2.3 AH)



Outer dimensions (mm)



Specifications

Nominal Voltage		12V
Rated capacity (20 hour rate)		2.3 Ah
Dimensions	Total Height	66 mm (2.60 inches)
	Height	60 mm (2.36 inches)
	Length	178 mm (7.01 inches)
	Width	34 mm (1.34 inches)
Weight Approx		0.96 Kg (2.11lbs)

Terminal Type (mm)

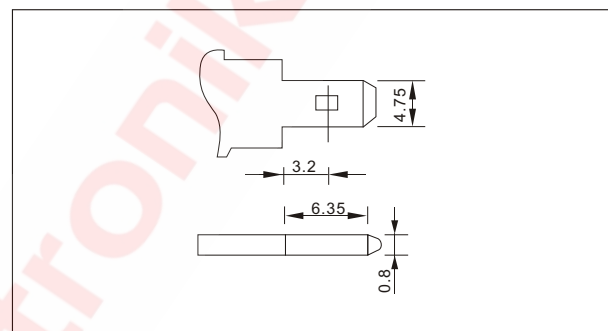

Characteristics

Capacity 25°C(77°F)	20 hour rate(0.115 A)	2.30 AH
	10 hour rate(0.21 A)	2.10 AH
	5 hour rate(0.39 A)	1.95 AH
	1 hour rate(1.38 A)	1.38 AH
	1.5 hour discharge to 10.5V	0.92 A
Internal Resistance	Full charged Battery at 25°C(77°F)	50 mΩ
Capacity affected by Temperature (20hour rate)	40°C(104°F)	102%
	25°C(77°F)	100%
	0°C(32°F)	85%
	-15°C(5°F)	65%
Self-Discharge at 25°C(77°F)	Capacity after 3 month storage	91%
	Capacity after 6 month storage	82%
	Capacity after 12 month storage	64%
Terminal		T0
Charge (constant Voltage)	Cycle	Initial Charging Current less than 0.92A Voltage 14.10-14.40V
	Float	Voltage 13.50-13.80V

Discharge Curves 25°C(77°F)

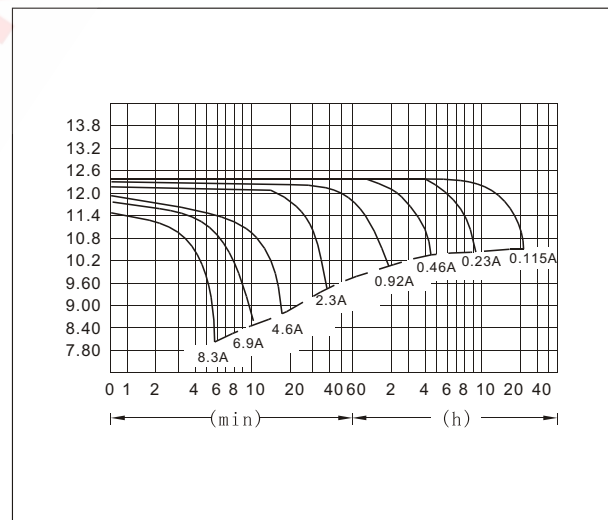

Constant Current(Amp) and Constant Power(Watt) Discharge Table at 25°C(77°F)

Time		5min	10min	15min	30min	1h	2h	3h	4h	5h	8h	10h	20h
9.60V	A	8.28	5.43	4.03	2.65	1.38	0.81	0.59	0.48	0.40	0.27	0.22	0.12
	W	85.9	58.3	43.2	28.4	14.9	8.84	6.59	5.35	4.59	3.05	2.51	1.38
10.20V	A	7.59	5.19	3.70	2.51	1.30	0.77	0.58	0.46	0.40	0.26	0.21	0.12
	W	81.5	58.1	41.4	28.2	14.7	8.90	6.66	5.35	4.61	3.06	2.51	1.36
10.50V	A	6.91	4.85	3.45	2.43	1.25	0.76	0.57	0.44	0.39	0.26	0.21	0.12
	W	75.9	55.2	39.4	28.0	14.5	8.78	6.59	5.11	4.62	3.04	2.50	1.36
10.80V	A	6.64	4.64	3.22	2.37	1.21	0.74	0.56	0.43	0.37	0.25	0.21	0.11
	W	74.5	53.5	37.1	27.4	14.1	8.64	6.55	5.07	4.42	2.99	2.45	1.34
11.10V	A	6.14	4.37	2.99	2.30	1.17	0.72	0.53	0.42	0.36	0.25	0.20	0.11
	W	69.6	50.6	34.8	26.9	13.7	8.50	6.26	5.02	4.27	2.94	2.43	1.32