

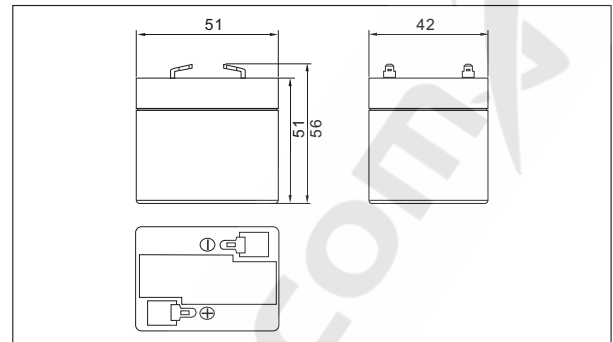

SW610(6V1.0AH)



● **Outer dimensions (mm)**



● **Specifications**

Nominal Voltage		6 V
Rated capacity (20hour rate)		1.0 Ah
Dimensions	Total Height	56mm (2.20 inches)
	Height	51mm (2.01 inches)
	Length	51mm (2.01 inches)
	Width	42 mm (1.65 inches)
Weight Approx		0.25Kg (0.49 lbs)

● **Terminal Type (mm)**

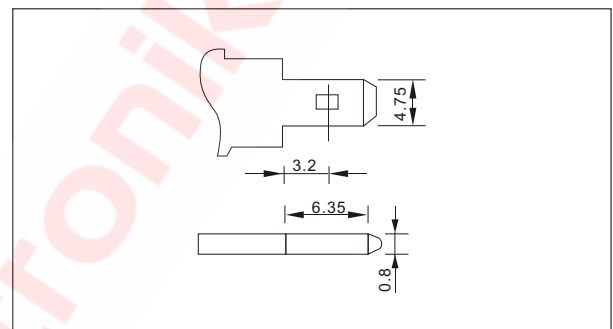

● **Characteristics**

Capacity 25°C(77°F)	20 hour rate(0.05 A)	1.00 AH
	10 hour rate(0.092 A)	0.92 AH
	5 hour rate(0.17 A)	0.85 AH
	1 hour rate(0.60 A)	0.60 AH
	1.5 hour discharge to 5.25V	0.4 A
Internal Resistance	Full charged Battery at 25°C(77°F)	40 mΩ
Capacity affected by Temperature (20hour rate)	40°C(104°F)	102%
	25°C(77°F)	100%
	0°C(32°F)	85%
	-15°C(5°F)	65%
Self-Discharge at 25°C(77°F)	Capacity after 3 month storage	91%
	Capacity after 6 month storage	82%
	Capacity after 12 month storage	64%
Terminal		T0
Charge (constant Voltage)	Cycle	Initial Charging Current less than 0.4 A Voltage 7.05-7.20 V
	Float	Voltage 6.75-6.90 V

● **Discharge Curves 25°C(77°F)**

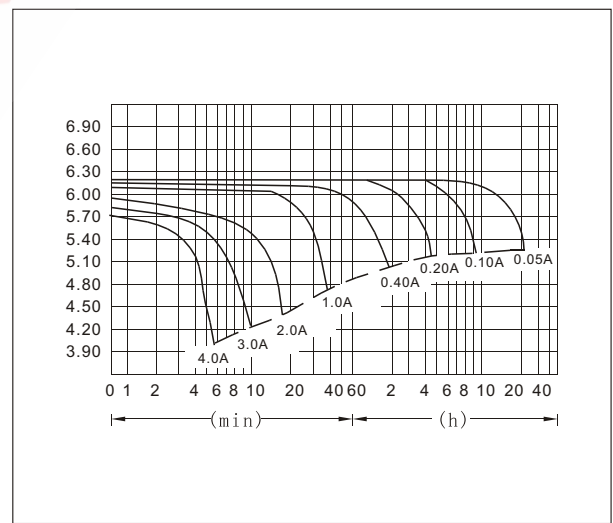

Constant Current(Amp) and Constant Power(Watt) Discharge Table at 25°C(77°F)

Time		5min	10min	15min	30min	1h	2h	3h	4h	5h	8h	10h	20h
4.80V	A	3.60	2.26	1.75	1.15	0.60	0.35	0.26	0.21	0.18	0.12	0.09	0.05
	W	21.2	13.3	10.1	6.1	3.5	2.0	1.49	1.20	1.01	0.67	0.55	0.30
5.10V	A	3.30	2.21	1.61	1.09	0.56	0.34	0.25	0.20	0.17	0.11	0.09	0.05
	W	20.0	13.1	9.5	6.1	3.3	1.9	1.45	1.16	1.00	0.66	0.54	0.29
5.25V	A	3.06	2.11	1.50	1.06	0.55	0.33	0.25	0.19	0.17	0.11	0.092	0.05
	W	19.3	12.3	9.1	6.0	3.2	1.9	1.42	1.10	0.99	0.65	0.53	0.29
5.40V	A	2.79	2.02	1.40	1.01	0.53	0.32	0.24	0.19	0.16	0.11	0.09	0.05
	W	18.4	11.9	8.7	6.0	3.1	1.9	1.41	1.09	0.95	0.63	0.52	0.28
5.55V	A	2.41	1.90	1.30	0.94	0.51	0.31	0.23	0.18	0.16	0.11	0.09	0.05
	W	14.4	11.5	8.3	5.9	3.0	1.9	1.36	1.08	0.93	0.60	0.51	0.28